

INSTALLATION & CARE

CUSTOM SEAT COVER INSTALLATION

BEFORE INSTALLATION:

- Read entire installation instructions before proceeding
- Use caution when reaching under power seats - some seats have sharp mechanisms.

1. If Your Seats Have Removable Headrests - Remove Them

Depending on your vehicle, you may have to press tab(s) in, poke a paperclip, or press in a slot. This may require two or more people. Here are some examples:

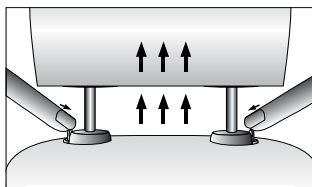

A. Tab(s) at headrest base

If your headrests have tab(s) at the base of the headrest, depress them and lift the headrest out. This may be easier with more than one person.

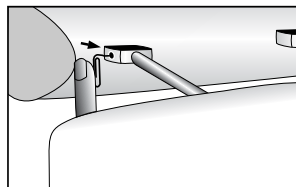

B. Pin holes on headrest

If your headrests have small holes instead of visible tabs, insert a paperclip end into the hole. While pressing the paperclip in, lift headrest. This may be easier with more than one person.

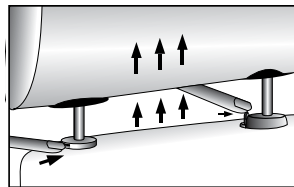

C. Slot and Tab at headrest base

If your headrests have tab(s) and a slot at the base of the headrest, depress the tab and press into the slot at the same time, and lift the headrest out. This may be easier with more than one person.

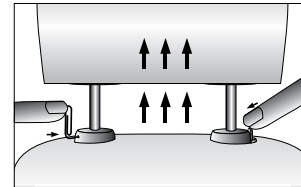

D. Pin hole and tab at headrest base

If your headrests have tab(s) and a pin hole at the base of the headrest, depress the tab and insert a paperclip end into the pinhole at the same time, and lift the headrest out.

2. Install Seat Back Cover

Depending on your seat style and vehicle, the installation process will differ. The following information will help you figure out how your specific covers install.



IMPORTANT: If your seats have integrated airbags, make sure you install the seat back covers in such a way that the airbag flaps are placed over the airbag location. Covers are labeled with stickers: "DRIVER" and "PASSENGER".

IF YOU DO NOT HAVE ACCESS THROUGH THE SEAT CUSHIONS:

If you are unable to place your hand through the middle of the seat cushions and see your fingers emerge from the other side, your vehicle may have a flap that is secured by metal rings or elastic straps. You'll need to release this flap to proceed. For more information please visit support.coverking.com.



SEAT BACK AND BOTTOM ONE PIECE?

Some vehicle seat designs require the backrest and seat bottom covers to be joined. After the covers are slipped over the seat back and bottom, there is a special accommodation that you push between the cushions. For more detailed information please visit install.coverking.com.

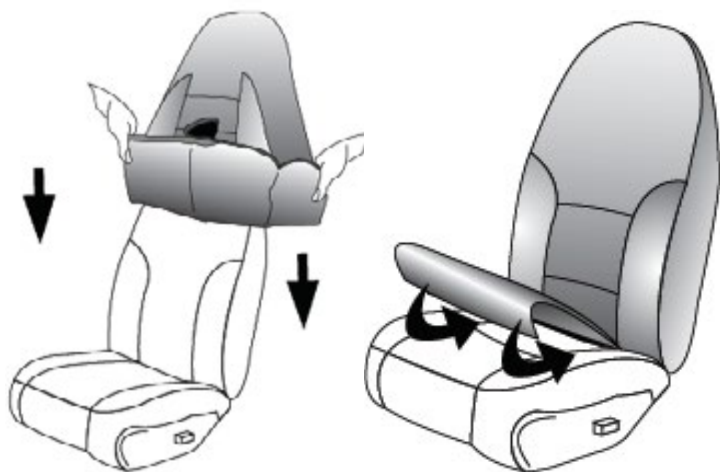

STEP 1. If the seat has an armrest, place it in the "up" position. If the cover has a zipper, unzip it. Pull cover over top of the seat. It may be helpful to start with the cover inside-out (as shown).

STEP 2. Pass the bottom flap through the opening between seat back and seat bottom, then attach velcro.

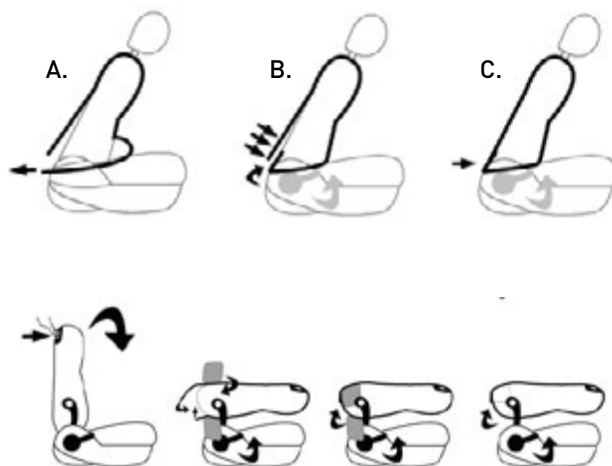

TIP 1: It may be easier (necessary on some seats) to fold your seat forward to pass the flap through.

3. Install Seat Bottom Cover

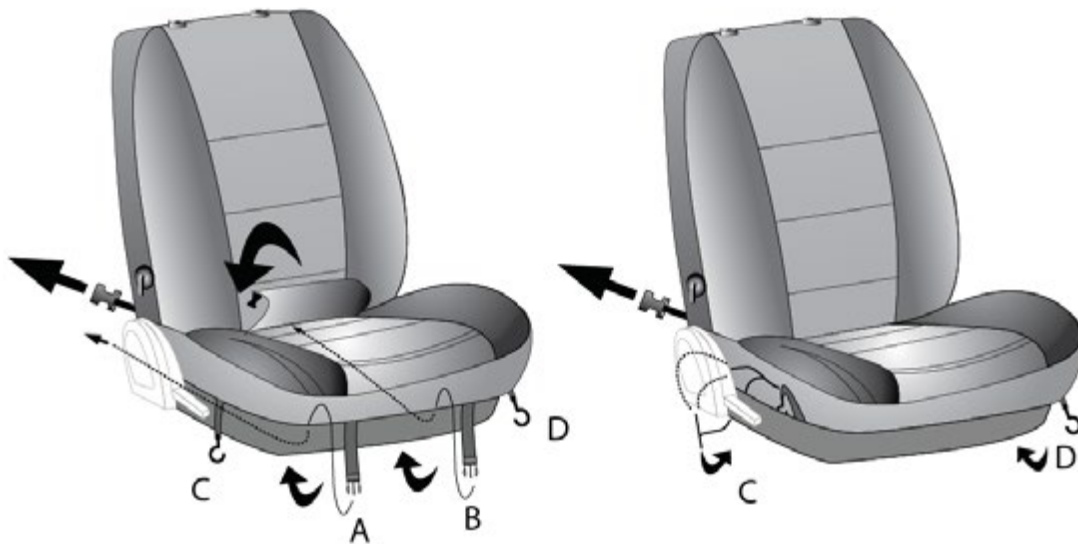

Step 1. Position cover over seat bottom. Pass flap between seat back and seat bottom. (Similar to the seat back cover installation, it may be easier if you fold the seat back forward) Join and tighten the buckles (A,B) under the seat.

Step 2. Then attach the side hooks (C,D) to the buckle straps.

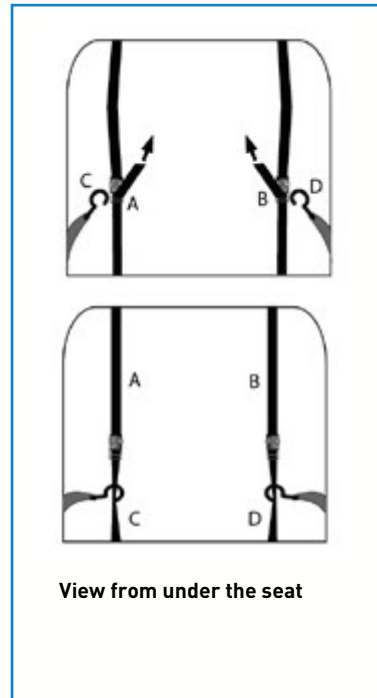

View from under the seat

4. Install Console Cover (If Applicable)

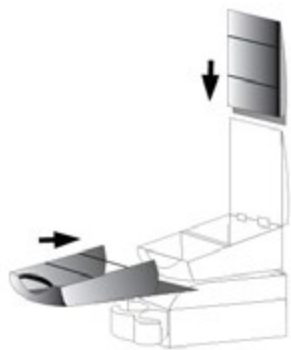

Step 1. Slide on console top, then console bottom.



Step 2. Pass console bottom flap through opening, then attach velcro.

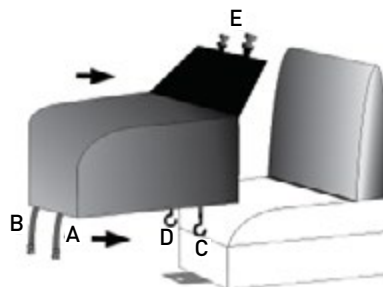

Step 3. Place base cover in place, slide flap (E) through. Attach and tighten the buckles (A,B) and attach hooks (C,D).

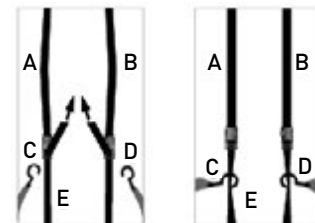
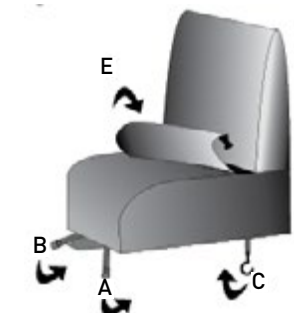

5. Finishing Touches

Headrest Holes: Before you reinstall your headrests, stretch the material over the headrest bases. Tuck the material under the bases for a super clean, tight finish. Reinstall headrest.



Tuck & Adjust: Adjust material around armrests, levers, lumbar support adjusters, etc. Material should be tucked under/behind.

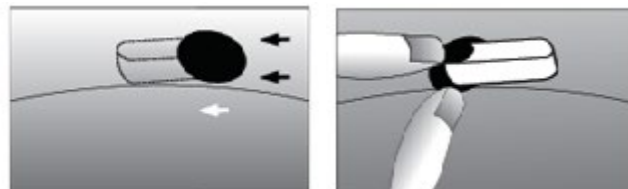

Tighten After Break-in: After the first 2 weeks of use, tighten the seat back covers by releasing the velcro, pulling the material very tight, then re-attaching the velcro. Also, tighten the seat bottom cover buckles.